

TEES | ELBOW SERIE ED

TUBE SIZE - FRACTIONAL

T Tube O.D.	Part number	L		d		F	Working Pressure	
		mm	inch	mm	inch	mm	PSIG	bar
1/4"	ED 14 2M	31,0	1,22	4,6	0,18	17	8000	550

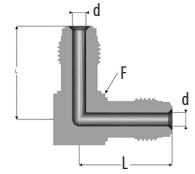

TEES | ELBOW SERIE ED

TUBE SIZE - FRACTIONAL

T Tube O.D.	Part number	L		d		F	F1	Working Pressure	
		mm	inch	mm	inch	mm	mm	PSIG	bar
1/4"	ED 14 FM	31,0	1,22	4,6	0,18	17	19,1	5100	350

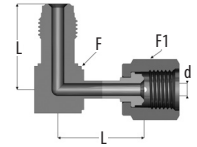

TEES | ELBOW SERIE ED

TUBE SIZE - FRACTIONAL

T Tube O.D.	Part number	L		d		F	F1	Working Pressure	
		mm	inch	mm	inch	mm	mm	PSIG	bar
1/4"	ED 14 2F	31,0	1,22	4,6	0,18	17	19,1	5100	350
1/4"	EDCA 14 2F	25,4	1,00	4,6	0,18	7,9	19,1	5100	350

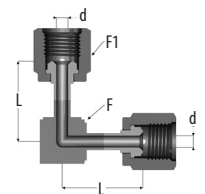

TEES | ELBOW SERIE EX

TUBE SIZE - FRACTIONAL

T Tube O.D.	Part number	L		d	C		F	Working Pressure	
		mm	inch	mm	mm	inch	mm	PSIG	bar
¼"	EX M. 14W ¹	31,0	1,22	4,6	19,1	0,75	17,0	5100	350

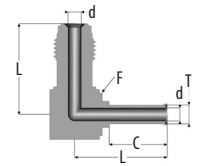
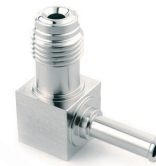

TEES | MINI ELBOW SERIE MG.EX

TUBE SIZE - FRACTIONAL

T1 Tube O.D.	T Tube O.D.	Part number	L		L1	d1	d	C		F	Working Pressure	
			mm	inch	mm	mm	mm	mm	inch	mm	PSIG	bar
¼"	¼"	MG. EX M.14	31,0	1,22	15,9	4,6	4,6	6,4	0,25	17,0	5100	350
⅜"	¼"	MG. EX M.38	31,0	1,22	15,9	7,7	4,6	6,4	0,25	17,0	3300	220
½"	¼"	MG. EX M.12	31,0	1,22	15,9	10,2	4,6	6,4	0,25	17,0	3500	240

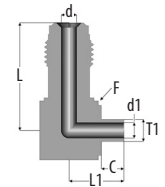

TEES | ELBOW SERIES EX

TUBE SIZE - FRACTIONAL

T Tube O.D.	Part number	L		d	C		F	F1	Working Pressure	
		mm	inch	mm	mm	inch	mm	mm	PSIG	bar
¼"	EX F. 14W ¹	31,0	1,22	4,6	19,1	0,75	17,0	19,1	5100	350

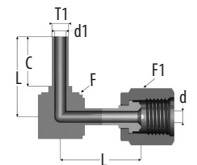

TEES | ELBOW SERIES EX

TUBE SIZE - FRACTIONAL

T1 Tube O.D.	T Tube O.D.	Part number	L		L1	d1	d	C		F	F1	Working Pressure	
			mm	inch	mm	mm	mm	mm	inch	mm	mm	PSIG	bar
¼"	¼"	MG. EX F.14	31,0	1,22	15,9	4,6	4,6	6,4	0,25	17,0	19,1	5100	350
⅜"	¼"	MG. EX F.38	31,0	1,22	15,9	7,7	4,6	6,4	0,25	17,0	19,1	3300	220
½"	¼"	MG. EX F.12	31,0	1,22	15,9	10,2	4,6	6,4	0,25	17,0	19,1	3500	240

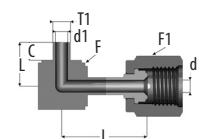
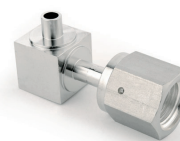

1) On request: it can be delivered with shoulder (Example: EX M.14)

TEES | TEE SERIE TD

TUBE SIZE - FRACTIONAL

T Tube O.D.	Part number	L		d		F	Working Pressure	
		mm	inch	mm	inch	mm	PSIG	bar
1/4"	TD 14 3M	31,0	1,22	4,6	0,18	17	8000	550

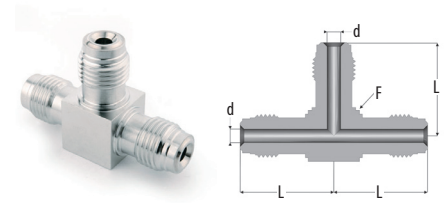

TEES | TEE SERIE TD

TUBE SIZE - FRACTIONAL

T Tube O.D.	Part number	L		d		F	F1	Working Pressure	
		mm	inch	mm	inch	mm	mm	PSIG	bar
1/4"	TD 14 F.2M	31,0	1,22	4,6	0,18	17	19,1	5100	350

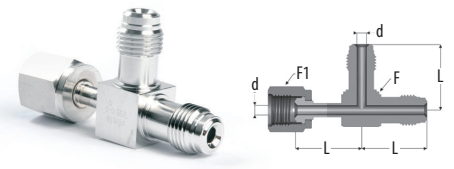

TEES | TEE SERIE TD

TUBE SIZE - FRACTIONAL

T Tube O.D.	Part number	L		d		F	F1	Working Pressure	
		mm	inch	mm	inch	mm	mm	PSIG	bar
1/4"	TD 14 MFM	31,0	1,22	4,6	0,18	17	19,1	5100	350

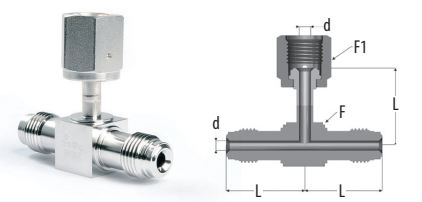

TEES | TEE SERIE TD

TEESING

WWW.TEESING.COM

TUBE SIZE - FRACTIONAL

T Tube O.D.	Part number	L		d		F	F1	Working Pressure	
		mm	inch	mm	inch	mm	mm	PSIG	bar
1/4"	TD 14 FMF	31,0	1,22	4,6	0,18	17	19,1	5100	350

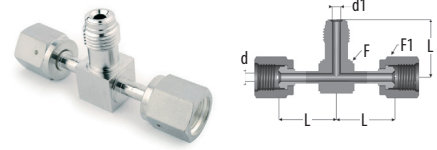

TEES | TEE SERIE TD

TUBE SIZE - FRACTIONAL

T Tube O.D.	Part number	L		d		F	F1	Working Pressure	
		mm	inch	mm	inch	mm	mm	PSIG	bar
1/4"	TD 14 M.2F	31,0	1,22	4,6	0,18	17	19,1	5100	350

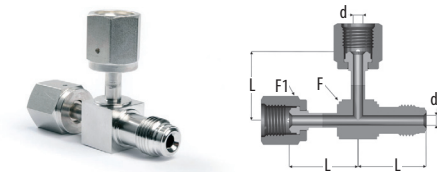

TEES | TEE SERIE TD

TUBE SIZE - FRACTIONAL

T Tube O.D.	Part number	L		d		F	F1	Working Pressure	
		mm	inch	mm	inch	mm	mm	PSIG	bar
1/4"	TD 14 3F	31,0	1,22	4,6	0,18	17	19,1	5100	350
1/4"	TDCA 14 3F	25,4	1,00	4,6	0,18	7,9	19,1	5100	350

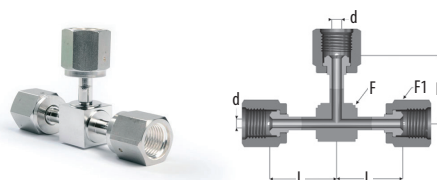

TEES | TEE SERIE TX

TUBE SIZE - FRACTIONAL

T1 Tube O.D.	T Tube O.D.	Part number	L		L1	d	C		F	Working Pressure	
			mm	inch	mm	mm	mm	inch	mm	PSIG	bar
¼"	¼"	TX 14 W.M.14W ¹	31,0	1,22	4,6	4,6	19,1	0,75	17,0	5100	350
⅜"	¼"	TX 38 W.M.38W ¹	31,0	1,22	7,7	4,6	19,1	0,75	17,0	3300	220
½"	¼"	TX 12 W.M.12W ¹	31,0	1,22	10,2	4,6	19,1	0,75	17,0	3500	240

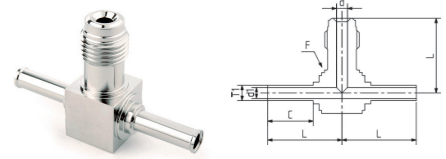

TEES | MINI TEE SERIE MG.TX

TUBE SIZE - FRACTIONAL

T1 Tube O.D.	T Tube O.D.	Part number	L		L1	d1	d	C		F	Working Pressure	
			mm	inch	mm	mm	mm	mm	inch	mm	PSIG	bar
¼"	¼"	MG.TX 14.M.14	31,0	1,22	15,9	4,6	4,6	6,4	0,25	17,0	5100	350
⅜"	¼"	MG.TX 38.M.38	31,0	1,22	15,9	7,7	4,6	6,4	0,25	17,0	3300	220

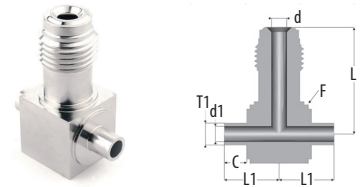

TEES | TEE SERIE TX

TUBE SIZE - FRACTIONAL

T1 Tube O.D.	T Tube O.D.	Part number	L		d1	d	C		F	F1	Working Pressure	
			mm	inch	mm	mm	mm	inch	mm	mm	PSIG	bar
¼"	¼"	TX 14W.F.14W ¹	31,0	1,22	4,6	4,6	19,1	0,75	17,0	19,1	5100	350
⅜"	¼"	TX 38W.F.38W ¹	31,0	1,22	7,7	4,6	19,1	0,75	17,0	19,1	3300	220

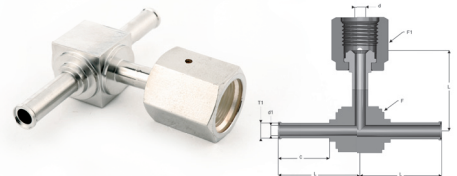

TEES | TEE SERIE MG.TX

TUBE SIZE - FRACTIONAL

T1 Tube O.D.	T Tube O.D.	Part number	L		L1	d1	d	C		F	F1	Working Pressure	
			mm	inch	mm	mm	mm	mm	inch	mm	mm	PSIG	bar
¼"	¼"	MG.TX 14.F.14	31,0	1,22	15,9	4,6	4,6	6,4	0,25	17,0	19,1	5100	350
⅜"	¼"	MG.TX 38.F.38	31,0	1,22	15,9	7,7	4,6	6,4	0,25	17,0	19,1	3300	220

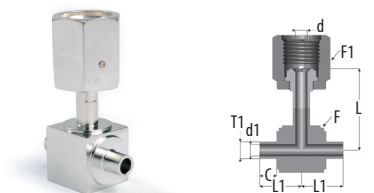

1) On request: it can be delivered with shoulder (Example: TX 14.M.14)

TEES | TEE SERIE TX

TUBE SIZE - FRACTIONAL

T Tube O.D.	Part number	L		C		d	F	Working Pressure	
		mm	inch	mm	inch			PSIG	bar
1/4"	TX 21 4W.M ¹	31,0	1,22	19,1	0,75	4,6	17	5100	350

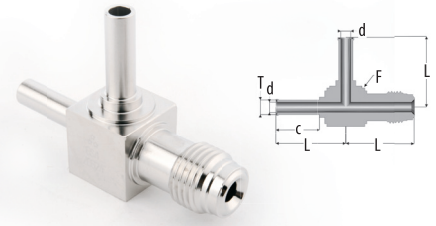

TEES | MINI TEE SERIE MG.TX

TUBE SIZE - FRACTIONAL

T Tube O.D.	Part number	L		L1	d	C		F	Working Pressure	
		mm	inch			mm	inch		mm	PSIG
1/4"	MG.TX 214 M	31,0	1,22	15,9	4,6	6,4	0,25	17,0	5100	350

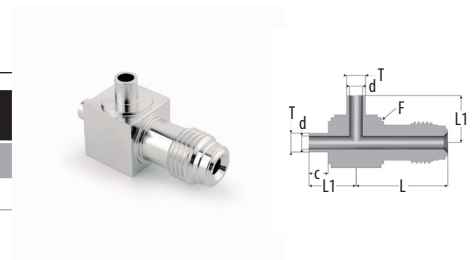

TEES | TEE SERIE TX

TUBE SIZE - FRACTIONAL

T Tube O.D.	Part number	L		d	C		F	F1	Working Pressure	
		mm	inch		mm	inch			mm	PSIG
1/4"	RX 214W.F ¹	31,0	1,22	4,6	19,1	0,75	17	19,1	5100	350

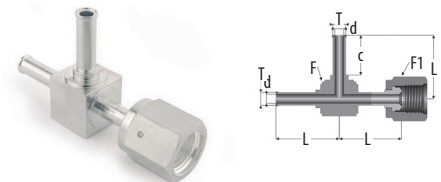

TEES | MINI TEE SERIE MG.TX

TUBE SIZE - FRACTIONAL

T Tube O.D.	Part number	L		L1	d	C		F	F1	Working Pressure	
		mm	inch			mm	inch			mm	PSIG
1/4"	MG.TX 214 F	31,0	1,22	15,9	4,6	6,4	0,25	17,0	19,1	5100	350

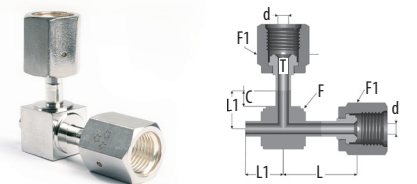

1) On request: it can be delivered with shoulder (Example: TX 214.M)

TEES | TEE SERIE TX

TUBE SIZE - FRACTIONAL

T Tube O.D.	Part number	L		d	C		F	Working Pressure	
		mm	inch	mm	mm	inch	mm	PSIG	bar
1/4"	TX 14W.2M ¹	31,0	1,22	4,6	19,1	0,75	17	5100	350

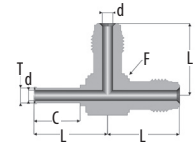
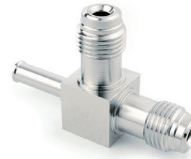

TEES | MINI TEE SERIE MG.TX

TUBE SIZE - FRACTIONAL

T Tube O.D.	Part number	L		L1	d	C		F1	Working Pressure	
		mm	inch	mm	mm	mm	inch	mm	PSIG	bar
1/4"	MG.TX 14.2M	31,0	1,22	15,9	4,6	6,4	0,25	17	5100	350

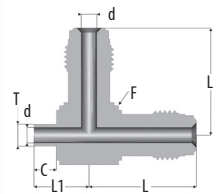
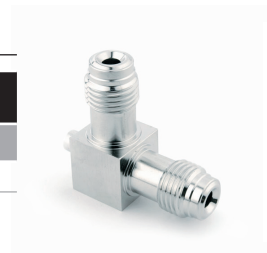

TEES | TEE SERIE TX

TUBE SIZE - FRACTIONAL

T Tube O.D.	Part number	L		d	C		F	F1	Working Pressure	
		mm	inch	mm	mm	inch	mm	mm	PSIG	bar
1/4"	TX 14W.FM ¹	31,0	1,22	4,6	19,1	0,75	17	19,1	5100	350

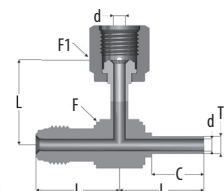

TEES | TEE SERIE MG.TX

TUBE SIZE - FRACTIONAL

T Tube O.D.	Part number	L		L1	d	C		F	F1	Working Pressure	
		mm	inch	mm	mm	mm	inch	mm	mm	PSIG	bar
1/4"	MG.TX 14.FM	31,0	1,22	15,9	4,6	6,4	0,25	17	19,1	5100	350

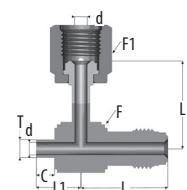

¹) On request: it can be delivered with shoulder (Example: TX 14.2M)

TEES | TEE SERIE TX

TEESING

WWW.TEESING.COM

TUBE SIZE - FRACTIONAL

T Tube O.D.	Part number	L		d	C		F	F1	Working Pressure	
		mm	inch	mm	mm	inch	mm	mm	PSIG	bar
1/4"	TX 14W.MF ¹	31,0	1,22	4,6	19,1	0,75	17	19,1	5100	350

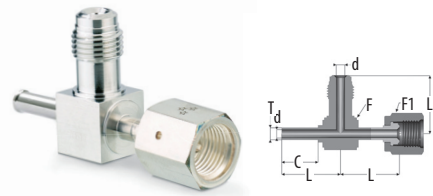

TEES | MINI TEE SERIE MG.TX

TUBE SIZE - FRACTIONAL

T Tube O.D.	Part number	L		L1	d	C		F	F1	Working Pressure	
		mm	inch	mm	mm	mm	inch	mm	mm	PSIG	bar
1/4"	MG.TX 14.MF	31,0	1,22	15,9	4,6	6,4	0,25	17	19,1	5100	350

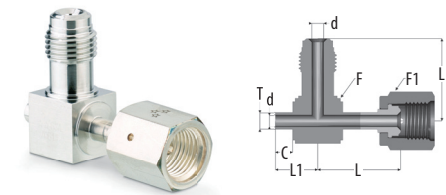

TEES | TEE SERIE TX

TUBE SIZE - FRACTIONAL

T Tube O.D.	Part number	L		d	C		F	F1	Working Pressure	
		mm	inch	mm	mm	inch	mm	mm	PSIG	bar
1/4"	TX 14W.2F ¹	31,0	1,22	4,6	19,1	0,75	17	19,1	5100	350

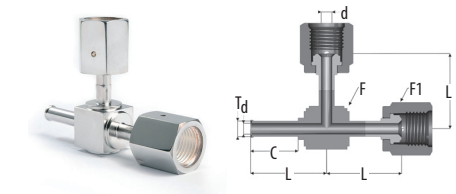

TEES | MINI TEE SERIE MG.TX

TUBE SIZE - FRACTIONAL

T Tube O.D.	Part number	L		L1	d	C		F	F1	Working Pressure	
		mm	inch	mm	mm	mm	inch	mm	mm	PSIG	bar
1/4"	MG.TX 14.2F ¹	31,0	1,22	15,9	4,6	6,4	0,25	17	19,1	5100	350

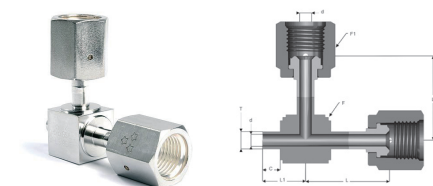

1) On request: it can be delivered with shoulder (Example: TX 14.MF)

TEES | TEE SERIE TX

TUBE SIZE - FRACTIONAL

T Tube O.D.	Part number	L		d	C		F	Working Pressure	
		mm	inch	mm	mm	inch	mm	PSIG	bar
¼"	TX M.14W.M ¹	31,0	1,22	4,6	19,1	0,75	17	5100	350

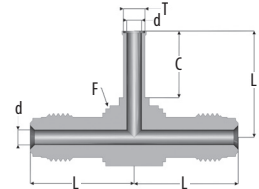
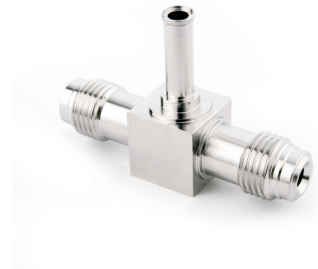

TEES | MINI TEE SERIE MG.TX

TUBE SIZE - FRACTIONAL

T Tube O.D.	Part number	L		L1	d	C		F	Working Pressure	
		mm	inch	mm	mm	mm	inch	mm	PSIG	bar
¼"	MG.TX M.14.M	31,0	1,22	15,9	4,6	6,4	0,25	17	5100	350

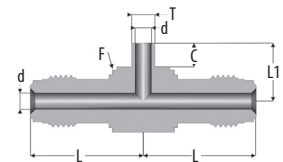

TEES | TEE SERIE TX

TUBE SIZE - FRACTIONAL

T Tube O.D.	Part number	L		d	C		F	F1	Working Pressure	
		mm	inch	mm	mm	inch	mm	mm	PSIG	bar
¼"	TX F.14W.M ¹	31,0	1,22	4,6	19,1	0,75	17	19,1	5100	350

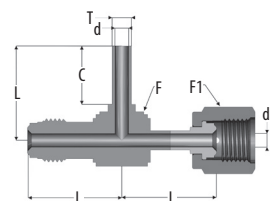
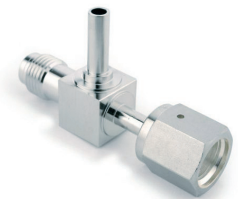

1) On request: it can be delivered with shoulder (Example: TX M.14.M)

TEES | MINI TEE SERIE MG.TX

TEESING

WWW.TEESING.COM

TUBE SIZE - FRACTIONAL

T Tube O.D.	Part number	L		L1	d	C		F	F1	Working Pressure	
		mm	inch	mm	mm	mm	inch	mm	mm	PSIG	bar
1/4"	MG.TX.F.14.M	31,0	1,22	15,9	4,6	6,4	0,25	17	19,1	5100	350

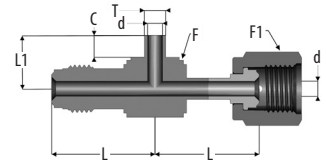
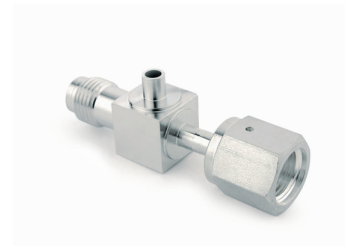

TEES | MINI TEE SERIE TX

TUBE SIZE - FRACTIONAL

T Tube O.D.	Part number	L		d	C	F	F1	Working Pressure		
		mm	inch	mm	mm	inch	mm	mm	PSIG	bar
1/4"	TX.F.14W.F ¹	31,0	1,22	4,6	19,1	0,75	17	19,1	5100	350

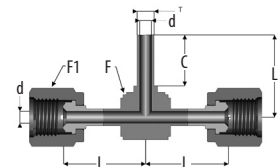

TEES | MINI TEE SERIES MG.TX

TUBE SIZE - FRACTIONAL

T Tube O.D.	Part number	L		L1	d	C	F	F1	Working Pressure		
		mm	inch	mm	mm	mm	inch	mm	mm	PSIG	bar
1/4"	MG.TX.F.14.F	31,0	1,22	15,9	4,6	6,4	0,25	17	19,1	5100	350

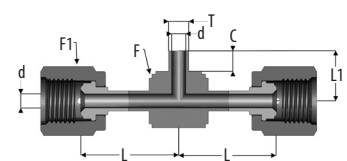
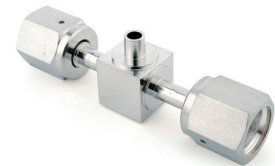

1) On request: it can be delivered with shoulder (Example: TX.F.14.F)

CROSSES | CROSS SERIE CD

TUBE SIZE - FRACTIONAL

T Tube O.D.	Part number	L		d		F	Working Pressure	
		mm	inch	mm	inch	mm	PSIG	bar
¼"	CD 14 4M	31,0	1,22	4,6	0,18	17	8000	550

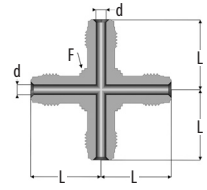

CROSSES | CROSS SERIE CD

TUBE SIZE - FRACTIONAL

T Tube O.D.	Part number	L		d		F	F1	Working Pressure	
		mm	inch	mm	inch	mm	mm	PSIG	bar
¼"	CD 14 F.3M	31,0	1,22	4,6	0,18	17	19,1	5100	350

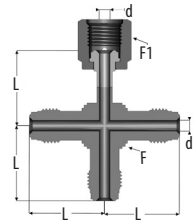

CROSSES | CROSS SERIE CD

TUBE SIZE - FRACTIONAL

T Tube O.D.	Part number	L		d		F	F1	Working Pressure	
		mm	inch	mm	inch	mm	mm	PSIG	bar
¼"	CD 14 2M.2F	31,0	1,22	4,6	0,18	17	19,1	5100	350

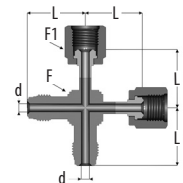



CROSSES | CROSS SERIE CD

TUBE SIZE - FRACTIONAL

T Tube O.D.	Part number	L		d		F	F1	Working Pressure	
		mm	inch	mm	inch	mm	mm	PSIG	bar
1/4"	CD 14 FMFM	31,0	1,22	4,6	0,18	17	19,1	5100	350

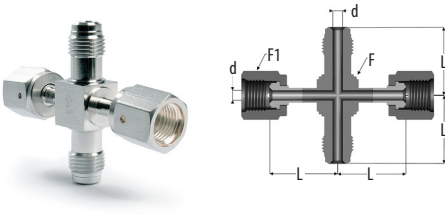

CROSSES | CROSS SERIE CD

TUBE SIZE - FRACTIONAL

T Tube O.D.	Part number	L		d		F	F1	Working Pressure	
		mm	inch	mm	inch	mm	mm	PSIG	bar
1/4"	CD 14 4F	31,0	1,22	4,6	0,18	17	19,1	5100	350

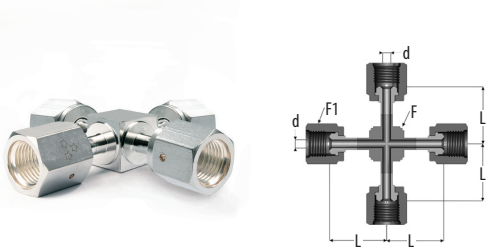

CROSSES | CROSS SERIE CX

TUBE SIZE - FRACTIONAL

T Tube O.D.	Part number	L		d	C		F	Working Pressure	
		mm	inch	mm	mm	inch	mm	PSIG	bar
1/4"	CX.M14W.M.14W ¹	31,0	1,22	4,6	19,1	0,75	17	5100	350

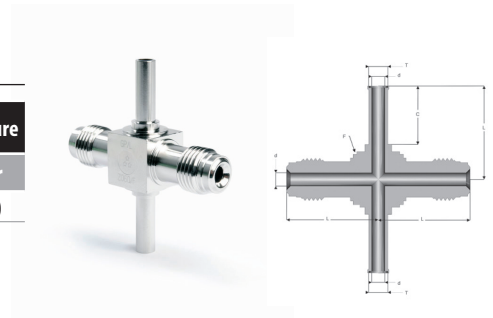

CROSSES | MINI CROSS SERIE MG.CX

TUBE SIZE - FRACTIONAL

T Tube O.D.	Part number	L		L1	d	C		F	Working Pressure	
		mm	inch	mm	mm	mm	inch	mm	PSIG	bar
1/4"	MG.CXM.14.M.14	31,0	1,22	15,9	4,6	6,4	0,25	17	5100	350

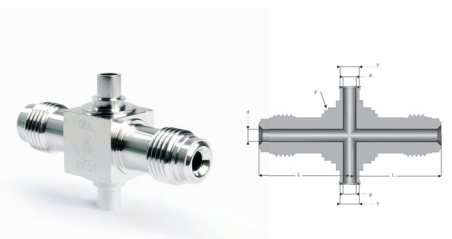

CROSSES | CROSS SERIE CX

TUBE SIZE - FRACTIONAL

T Tube O.D.	Part number	L		d	C		F	F1	Working Pressure	
		mm	inch	mm	mm	inch	mm	mm	PSIG	bar
1/4"	CX.F.14W.M12W ¹	31,0	1,22	4,6	19,1	0,75	17	19,1	5100	350

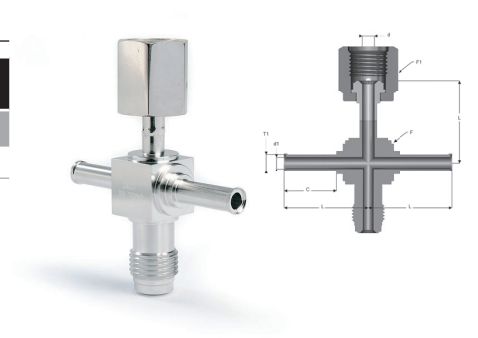

1) On request: it can be delivered with shoulder (Example: CX.M.14.M.14)

CROSSES | MINI CROSS SERIE MG.CX



WWW.TEESING.COM

TUBE SIZE - FRACTIONAL

T Tube O.D.	Part number	L		L1	d		C		F	F1	Working Pressure	
		mm	inch		mm	mm	inch	mm	mm	PSIG	bar	
1/4"	MG.CX.F.14.M.14	31,0	1,22	15,9	4,6	6,4	0,25	17	19,1	5100	350	

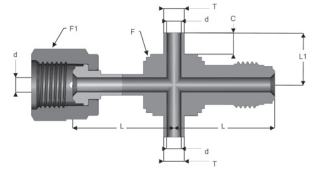

CROSSES | CROSS SERIE CX

TUBE SIZE - FRACTIONAL

T Tube O.D.	Part number	L		d	C		F	F1	Working Pressure	
		mm	inch	mm	mm	inch	mm	mm	PSIG	bar
1/4"	CX.F.14W.F.14W ¹	31,0	1,22	4,6	19,1	0,75	17	19,1	5100	350

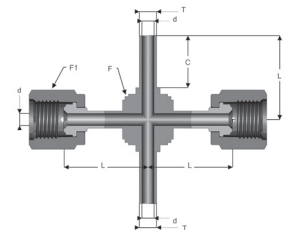

CROSSES | MINI CROSS SERIE MG.CX

TUBE SIZE - FRACTIONAL

T Tube O.D.	Part number	L		L1	d		C		F	F1	Working Pressure	
		mm	inch	mm	mm	mm	inch	mm	mm	PSIG	bar	
1/4"	MG.CX.F.14.F.14	31,0	1,22	15,9	4,6	6,4	0,25	17	19,1	5100	350	

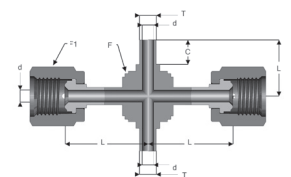

1) On request: it can be delivered with shoulder (Example: CX.F.14.F.14)